

LB-15-25-C-1.85FSPO Standard Gain Horn Antenna 50-65GHz 25dB Gain 1.85mm Female

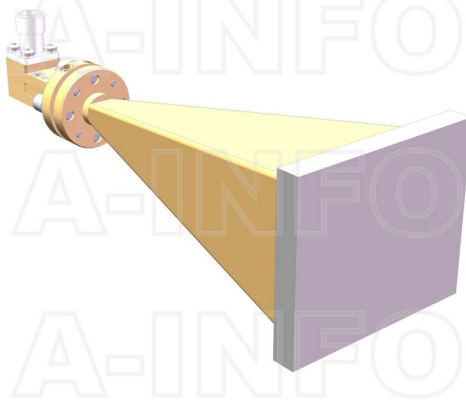

Standard Gain Horn Antenna Operating From 50GHz to 65GHz With a Nominal 25dB Gain With 1.85mm Female Connector

Product Information

SKU	LB-15-25-C-1.85FSPO
-----	---------------------

Description

Standard Gain Horn Antenna LB-15-25-C-1.85FSPO, operating from 50 to 65GHz with a nominal 25dB gain and low VSWR 2:1 with 1.85mm Female connector output. The model LB-15-25-C-1.85FSPO has uniform gain through its frequency span, providing efficient performance characteristics and directionality. It can handle 5W continuously and 10W peak power. Constructed of lightweight corrosion-resistant aluminum, the horn comes with a specially designed weatherproof radome which provides excellent protection against the rain and dust but has very little loss across the full operating frequency band. This standard gain horn antenna is linearly polarized and ideally suited for EMI testing, direction finding, surveillance, antenna gain and pattern measurements and other applications.

Technical Specification

Electrical Specification		Interface	
Frequency, Min (GHz)	50	Output Type	Coaxial
Frequency, Max (GHz)	65	Connector	1.85mm(V)
Waveguide Type	Rectangular	Connector Gender	Female
Waveguide Size EIA WR	WR15	Mechanical Specification	
Gain, Typ (dBi)	25	Figure	C Type
Polarization	Linear	Body Material	Cu
3dB Beamwidth, E-Plane, Typ (Deg.)	9	Finish	Gold Plated, Gray Paint
3dB Beamwidth, H-Plane, Typ (Deg.)	11	Size, W (mm)	43
Cross Pol. Isolation, Typ (dB)	40	Size, H (mm)	36
VSWR, Typ	2:1	Size, L (mm)	121.9
Impedance, (Ohm)	50	Weight, (kg)	0.1
Power Handling, CW, (W)	5		
Power Handling, Peak, (W)	10		

Additional Information

Application	Outdoor, Waterproof and Dustproof, Fixed	Solution for	Gain Reference Antenna Measurement Reflector Feed Far-field Measurement System Intergration Material Measurement
-------------	--	--------------	---

Outline Drawing

1.85mm-Female Output with Radome (Option, P/N: LB-15-25-C-1.85FSPO, Outdoor Application)

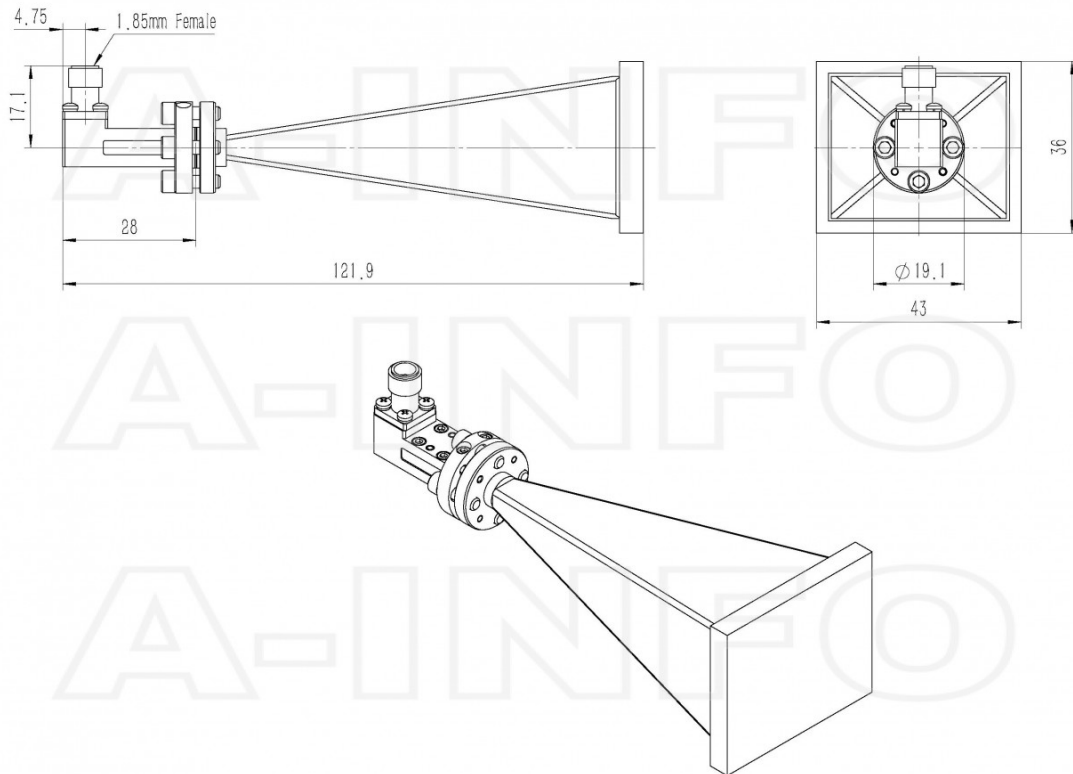

1.85mm-Female Output with Round Mounting Bracket & Radome (Option, P/N: LB-15-10-C-MB & LB-15-25-C-1.85FSPO, Outdoor Application)

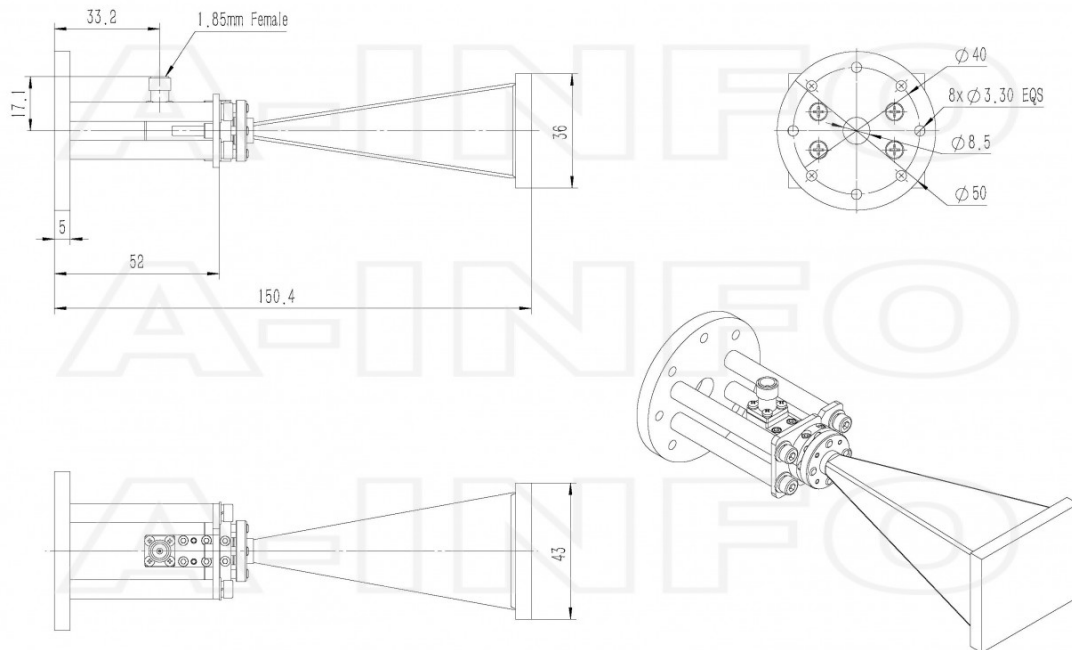

1.85mm-Female Output with L Type Mounting Bracket & Radome (Option, P/N: LB-15-10-C-MBL & LB-15-25-C-1.85FSPO, Outdoor Application)

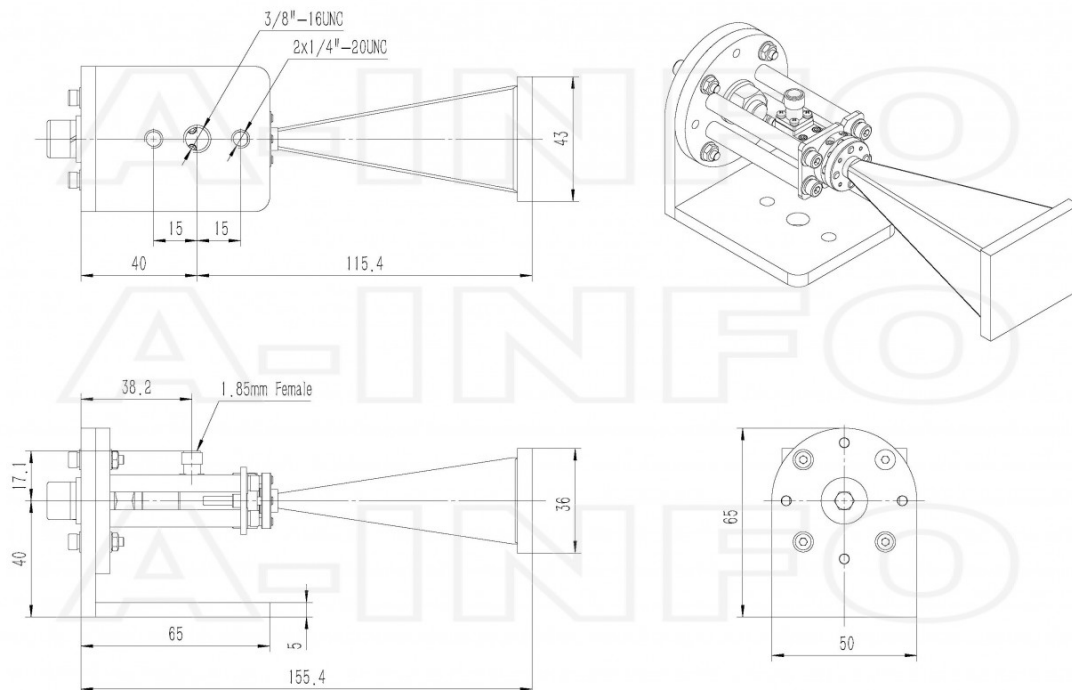

Typical Test Results

Gain

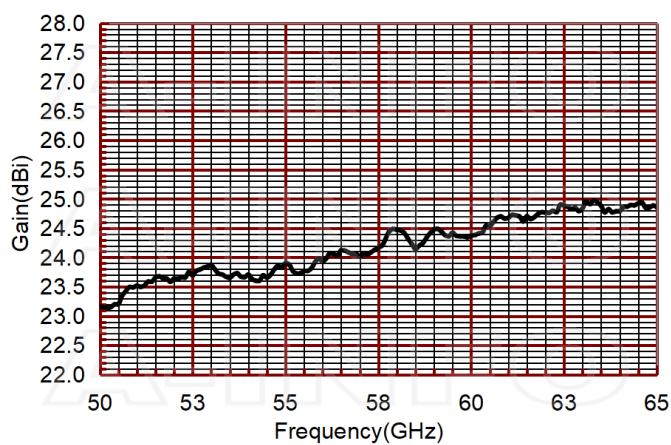

Antenna Factor

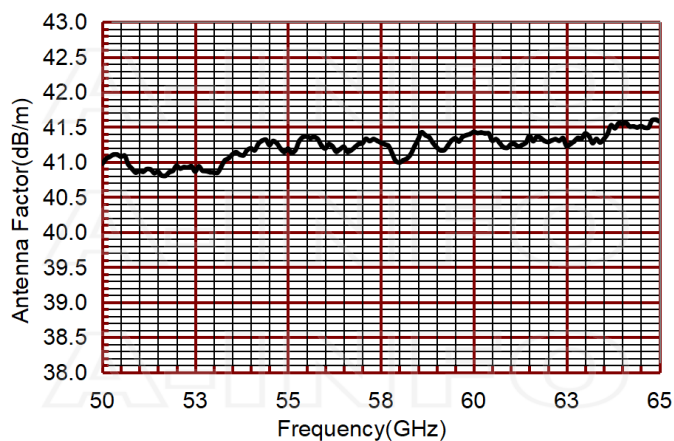

Antenna Factor (Table)

Frequency (GHz)	Gain (dBi)	Antenna Factor (dB/m)
50.0	23.21	40.98
52.0	23.58	40.95
54.0	23.66	41.19
56.0	23.98	41.19
58.0	24.49	40.99
60.0	24.34	41.43
62.0	24.77	41.29
64.0	24.79	41.55
65.0	24.89	41.58

Cross Polarization Isolation

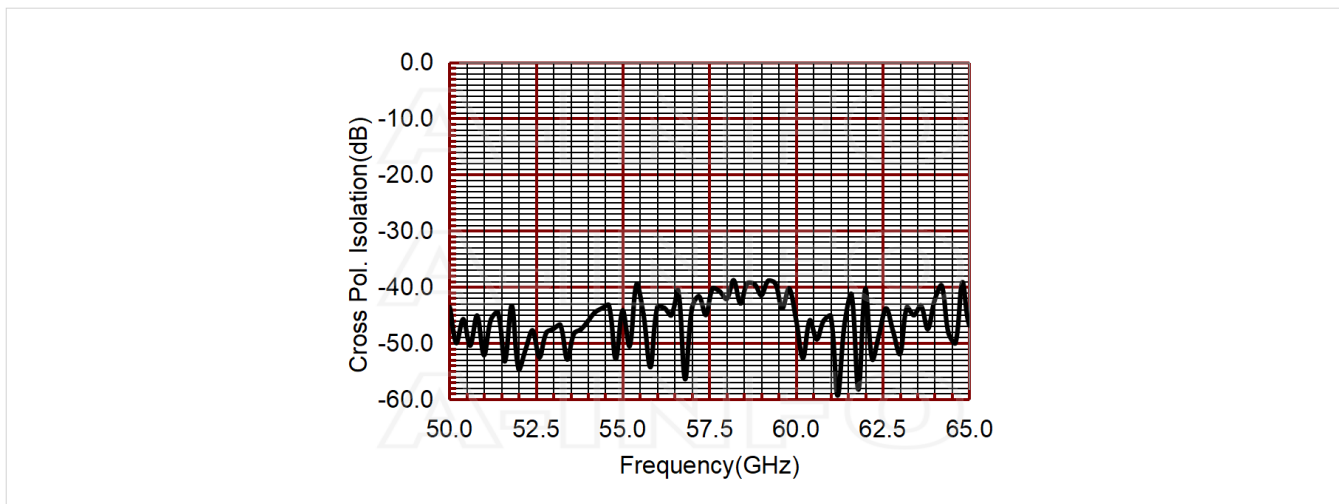

VSWR

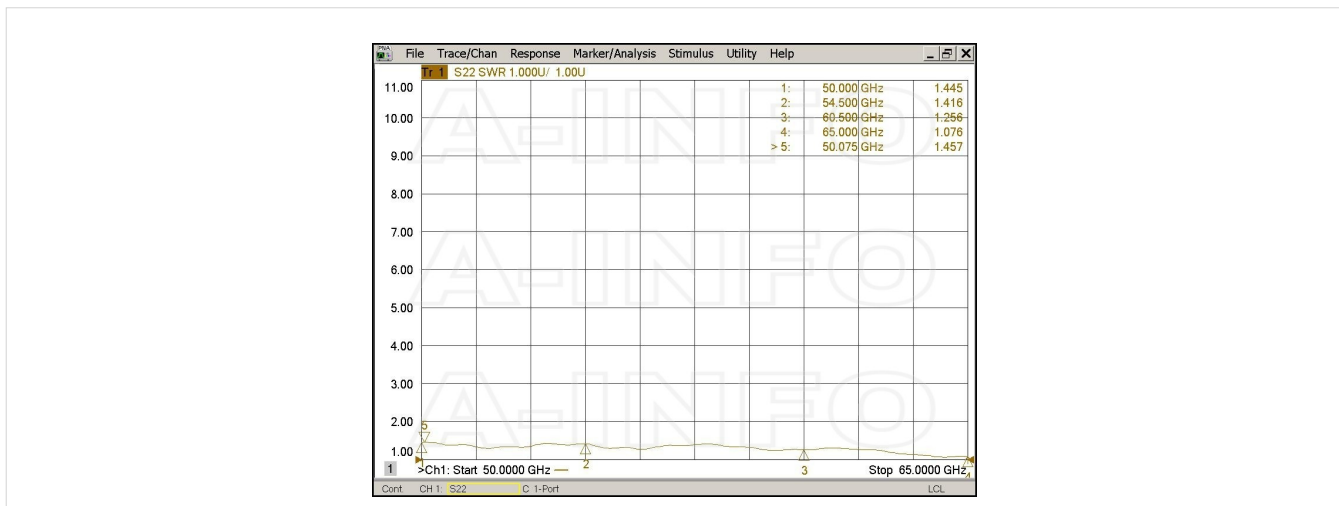

Pattern

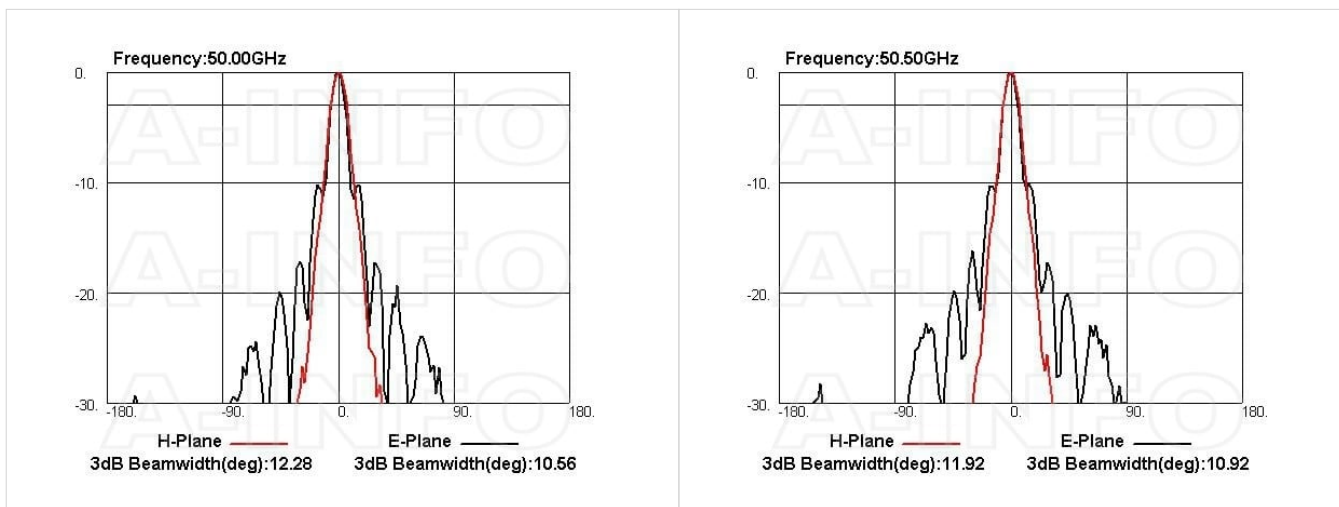

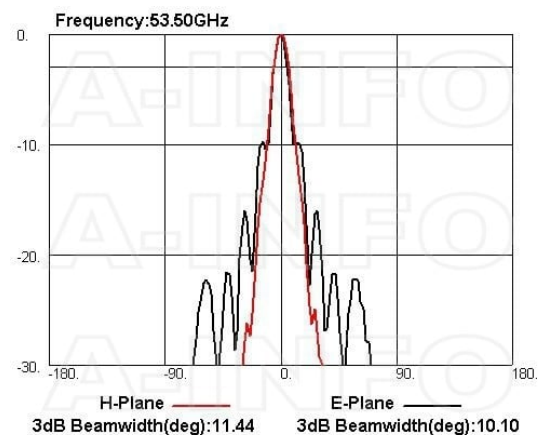
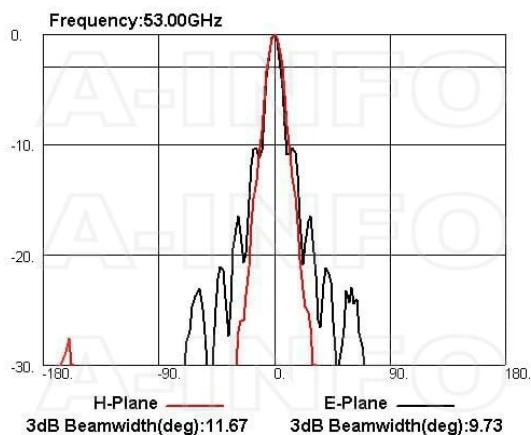
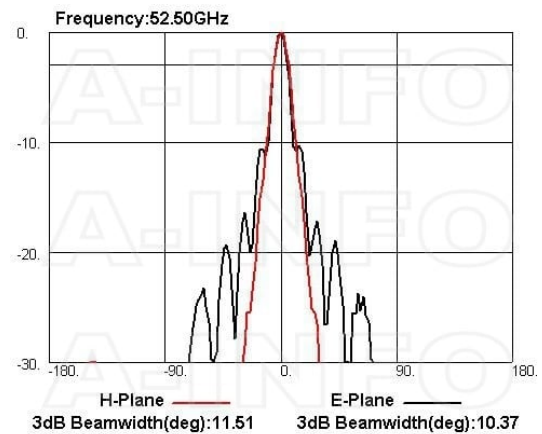
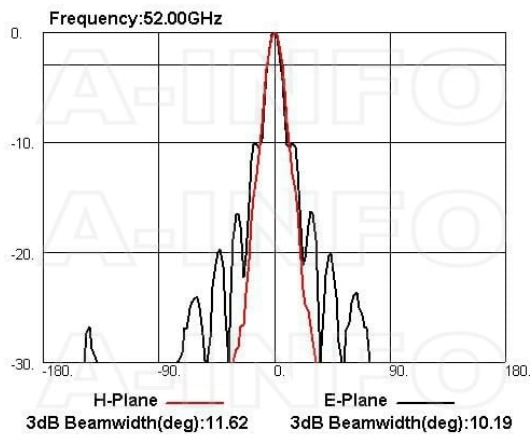
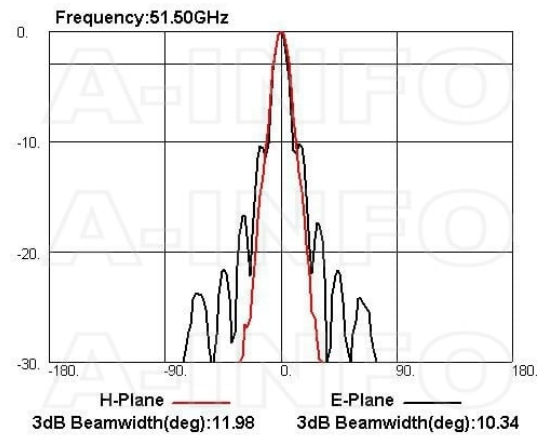
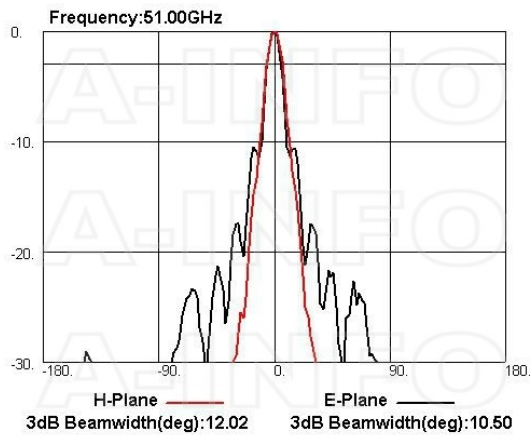

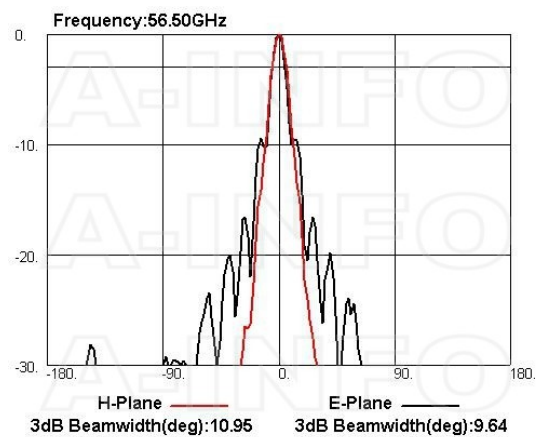
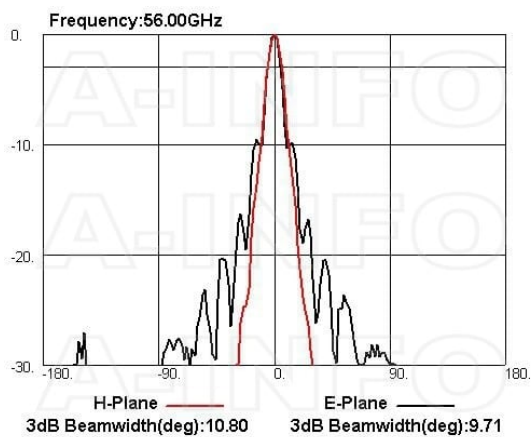
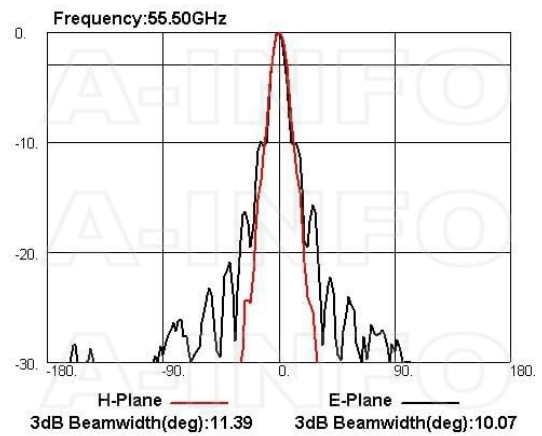
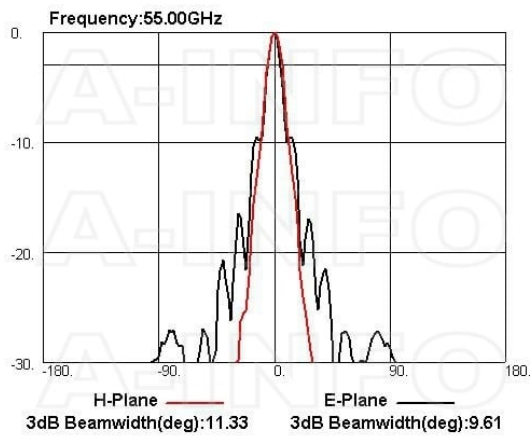
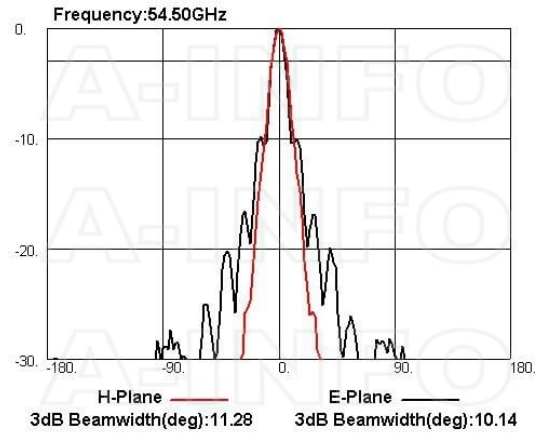
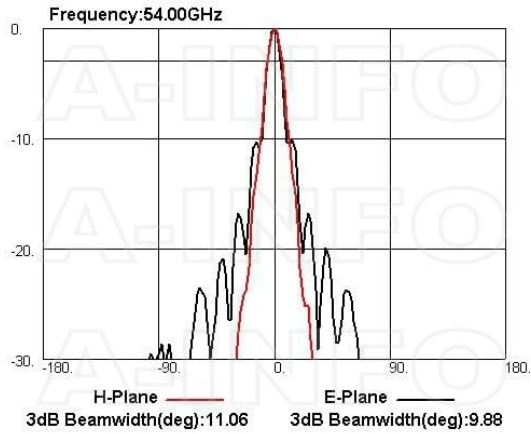

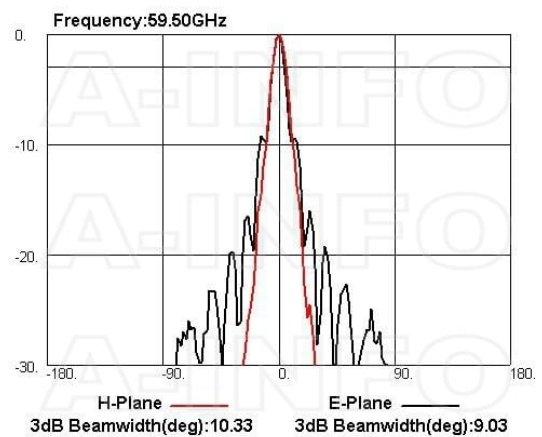
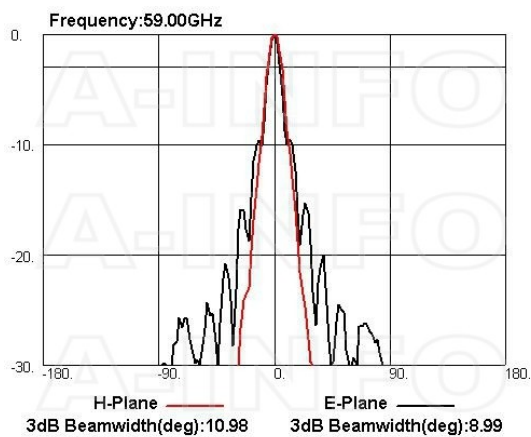
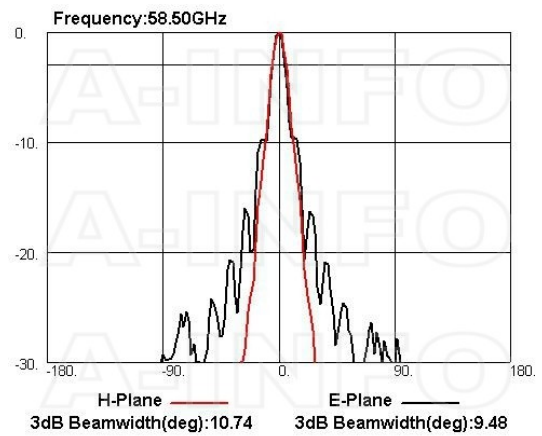
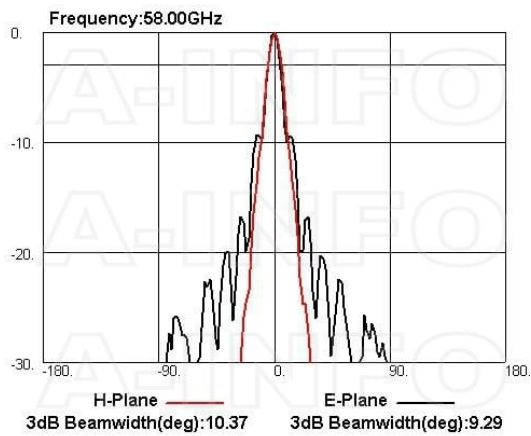
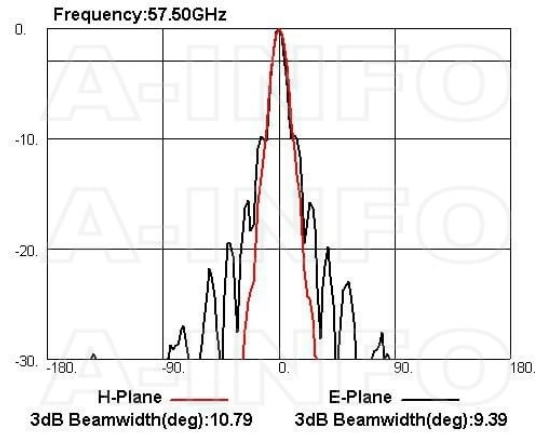
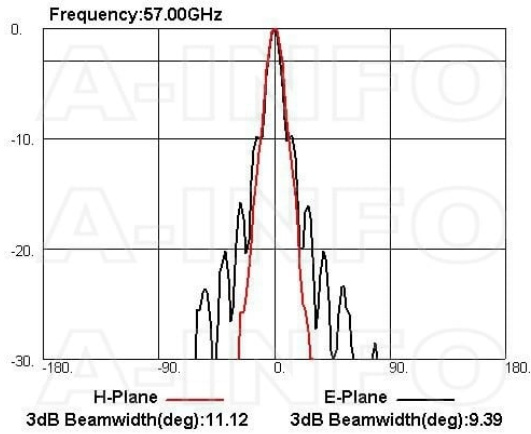

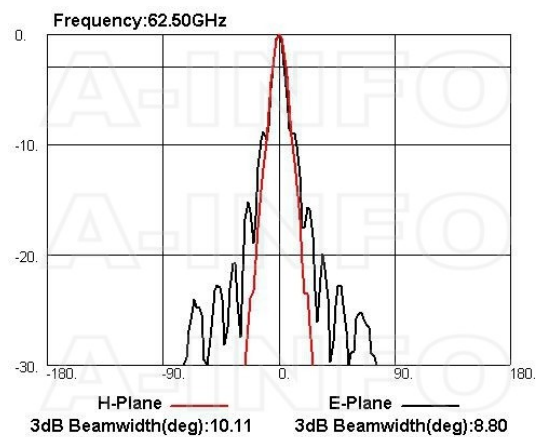
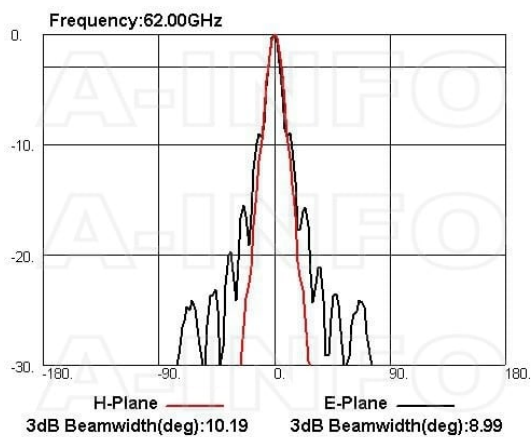
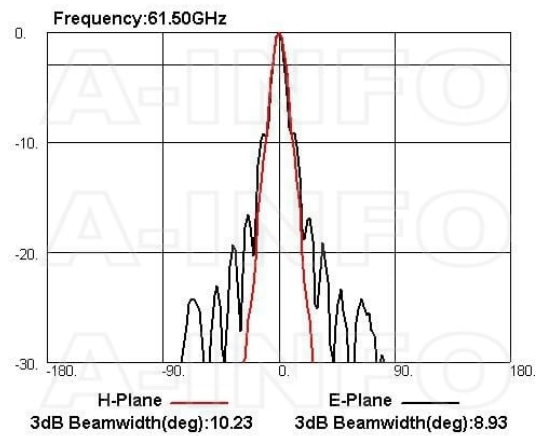
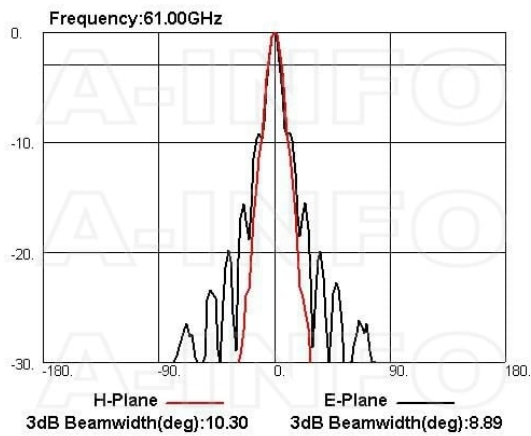
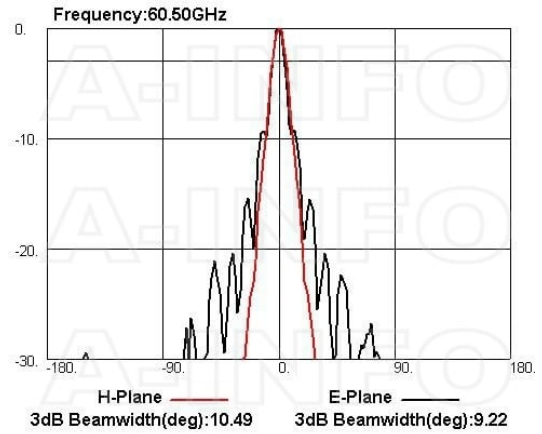
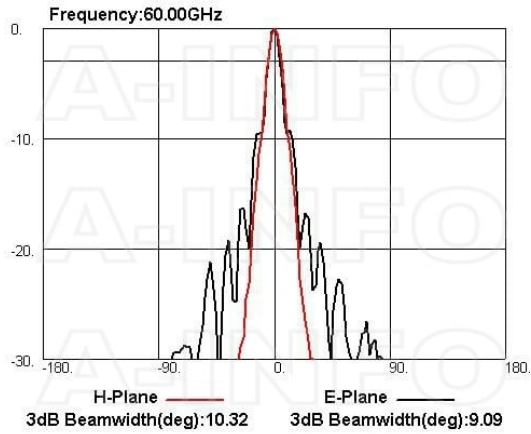

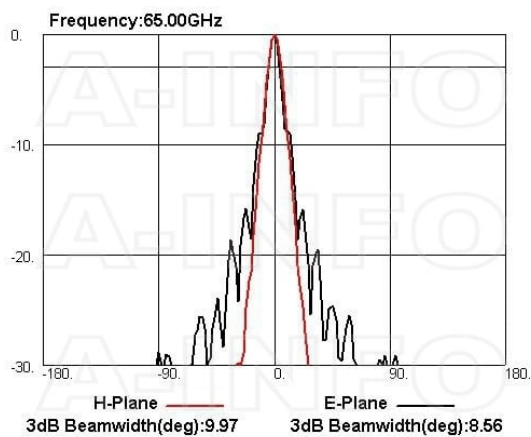
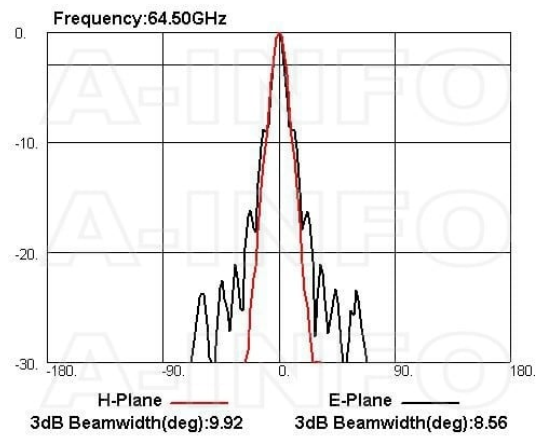
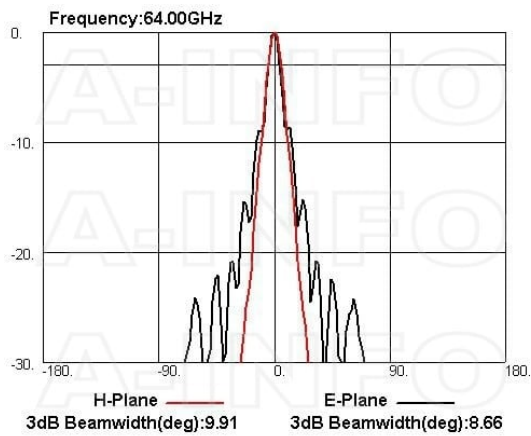
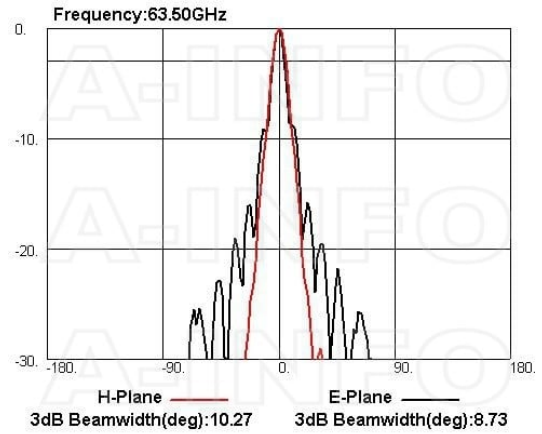
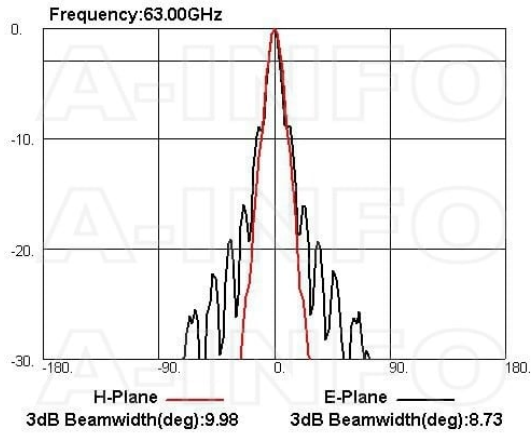

Related Products



LB-15-10-C-MB Round Type Mounting Bracket



LB-15-10-C-MBL L type mounting bracket



Tripod_15Kg Al Alloy Tripod



3033HL Wooden Tripod



3033QM Wooden Tripod Metalfree



Carrying Case_LB-15-25-C Al Alloy Carrying Case



1.85M-1.85M-B010-200 Flexible Cable Assembly 200mm DC-67GHz 1.85mm Male to 1.85mm Male



1.85M-1.85M-B010-300 Flexible Cable Assembly 300mm DC-67GHz 1.85mm Male to 1.85mm Male



1.85M-1.85M-B010-500 Flexible Cable Assembly 500mm DC-67GHz 1.85mm Male to 1.85mm Male



1.85M-1.85M-B010-1000 Flexible Cable Assembly 1000mm DC-67GHz 1.85mm Male to 1.85mm Male



1.85M-1.85M-B010-1500 Flexible Cable Assembly 1500mm DC-67GHz 1.85mm Male to 1.85mm Male



1.85M-1.85M-B010-2000 Flexible Cable Assembly 2000mm DC-67GHz 1.85mm Male to 1.85mm Male



1.85M-1.85M-B010-3000 Flexible Cable Assembly 3000mm DC-67GHz 1.85mm Male to 1.85mm Male



1.85M-1.85M-B010-5000 Flexible Cable Assembly 5000mm DC-67GHz 1.85mm Male to 1.85mm Male



1.85M-1.85M-B010-10000 Flexible Cable Assembly 10000mm DC-67GHz 1.85mm Male to 1.85mm Male



1.85M-1.85M-B010S-500 Flexible Cable Assembly 500mm DC-67GHz 1.85mm Male to 1.85mm Male



1.85M-1.85M-B010S-1000 Flexible Cable Assembly 1000mm DC- 67GHz 1.85mm Male to 1.85mm Male



1.85M-1.85M-B010S-1500 Flexible Cable Assembly 1500mm DC- 67GHz 1.85mm Male to 1.85mm Male



1.85M-1.85M-B010S-2000 Flexible Cable Assembly 2000mm DC- 67GHz 1.85mm Male to 1.85mm Male



1.85M-1.85M-B010S-3000 Flexible Cable Assembly 3000mm DC- 67GHz 1.85mm Male to 1.85mm Male



1.85M-1.85M-B010S-5000 Flexible Cable Assembly 5000mm DC- 67GHz 1.85mm Male to 1.85mm Male



1.85M-1.85M-B010S-10000 Flexible Cable Assembly 10000mm DC- 67GHz 1.85mm Male to 1.85mm Male



1.85M-1.85F-B010-500 Flexible Cable Assembly 500mm DC- 67GHz 1.85mm Male to 1.85mm Female



1.85M-1.85F-B010-1000 Flexible Cable Assembly 1000mm DC- 67GHz 1.85mm Male to 1.85mm Female



1.85M-1.85F-B010-1500 Flexible Cable Assembly 1500mm DC- 67GHz 1.85mm Male to 1.85mm Female



1.85M-1.85F-B010-2000 Flexible Cable Assembly 2000mm DC- 67GHz 1.85mm Male to 1.85mm Female



1.85M-1.85F-B010-2500 Flexible Cable Assembly 2500mm DC- 67GHz 1.85mm Male to 1.85mm Female



1.85M-1.85F-B010-3000 Flexible Cable Assembly 3000mm DC- 67GHz 1.85mm Male to 1.85mm Female



1.85M-1.85F-B010-5000 Flexible Cable Assembly 5000mm DC- 67GHz 1.85mm Male to 1.85mm Female



1.85M-1.85F-B010-10000 Flexible Cable Assembly 10000mm DC- 67GHz 1.85mm Male to 1.85mm Female



1.85M-1.85F-B010S-500 Flexible Cable Assembly 500mm DC- 67GHz 1.85mm Male to 1.85mm Female



1.85M-1.85F-B010S-1000 Flexible Cable Assembly 1000mm DC- 67GHz 1.85mm Male to 1.85mm Female



1.85M-1.85F-B010S-1500
Flexible Cable Assembly 1500mm
DC- 67GHz 1.85mm Male to
1.85mm Female



1.85M-1.85F-B010S-2000
Flexible Cable Assembly 2000mm
DC- 67GHz 1.85mm Male to
1.85mm Female



1.85M-1.85F-B010S-3000
Flexible Cable Assembly 3000mm
DC- 67GHz 1.85mm Male to
1.85mm Female



1.85M-1.85F-B010S-5000
Flexible Cable Assembly 5000mm
DC- 67GHz 1.85mm Male to
1.85mm Female



1.85M-1.85F-B010S-10000
Flexible Cable Assembly
10000mm DC- 67GHz 1.85mm
Male to 1.85mm Female

Similar Products



LB-15-25-A Standard Gain Horn
Antenna 50-75GHz 25dB Gain
Rectangular Waveguide Interface

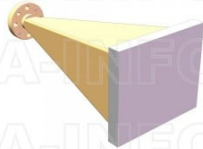

LB-15-25-ASPO Standard Gain
Horn Antenna 50-75GHz 25dB
Gain Rectangular Waveguide
Interface



LB-15-25-C-1.85F Standard Gain
Horn Antenna 50-65GHz 25dB
Gain 1.85mm Female



LB-15-25-C-1.0F Standard Gain
Horn Antenna 50-75GHz 25dB
Gain 1.0mm Female



LB-15-25-C-1.0FSPO Standard
Gain Horn Antenna 50-75GHz
25dB Gain 1.0mm Female

About this Datasheet

<ul style="list-style-type: none"> ● Product Information <p>Product Link: https://www.ainfoinc.com/lb-15-25-c-1-85fspo-standard-gain-horn-antenna-50-65-ghz-25db-gain-1-85mm-female Data subject to change without notice. © A-INFO INC. 2023. All Rights Reserved</p>	<ul style="list-style-type: none"> ● Contact Us <p>Address: 60 Tesla, Irvine, CA 92618, USA</p> <p>Website: www.ainfoinc.com</p> <p>Email: sales@ainfoinc.com</p>	<ul style="list-style-type: none"> ● Phone & Fax <p>Phone: +1-949-639-9688 +1-949-639-9608</p> <p>Fax: +1-949-639-9670</p>
---	--	---